

MORE THAN
22
YEARS EXPERIENCE

CAE[®]
SHIFTING TECHNOLOGY

Installation instructions

📍 10072

Nissan 350 Z
6-speed gearbox

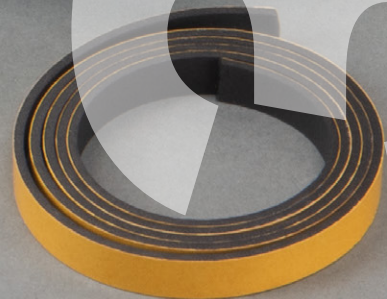
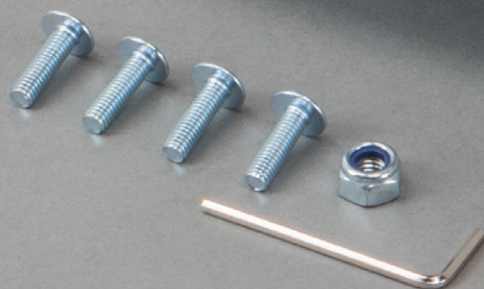

PLEASE NOTE

SAFETY FIRST!

- 📍 Raise the vehicle safely with a vehicle lift for installation. Improper lifting can cause damage to the vehicle and/or personal injury or even death!
- 📍 Please only do the installation if you have appropriate experience in the automotive sector and have the right tools! An incorrectly installed Shifter can seriously damage the transmission or make the vehicle undriveable or not shiftable and lead to serious accidents!
- 📍 If work on the electrical system is necessary, please follow the manufacturer's specifications.
- 📍 Carry out all work with care and cleanliness! For the professional assembly of a shifter is no force required. All parts are designed to fit your vehicle.
- 📍 If you are unsure, please contact your trusted workshop about the installation!

BASICALLY

- 📍 Use ethyl alcohol/brake cleaner to clean all aluminum parts.
- 📍 Occasionally lubricate all moving parts with spray grease, which has good creeping properties. Our recommendation: Würth HHS 2000 (WD-40 or similar is unsuitable because it is too thin)
- 📍 All screws and nuts that are not self-locking or are fitted with tooth lock washers glue in during assembly!
- 📍 Never kink shift cables, please!

i SURFACES AND THEIR CARE

Please note that an untreated aluminum surface (ALU) is sensitive to aggressive Liquids to which i.a. Hand sweat also counts. Especially the high-strength 7075 aluminum we use has a tendency to form black spots of corrosion due to its high copper content. Under special circumstances, very salty air near the sea and coast can lead to corrosion. The surfaces should therefore be cleaned regularly and treated with care to prevent this. For this purpose, e.g. ethyl alcohol or brake cleaner. Only spray these onto a cloth and wipe the shifter with it, NEVER spray the shifter directly. If stains have already formed, they can be removed with commercially available aluminum polish, but that is also not allowed get into the movable parts of the shifter. The anodized versions of our shifters (EXS, EXGR) are more resistant to corrosion. The steel parts have to be also cared in all variants.

TIPS FOR GEAR SHIFTING

i FORCE DOESN'T MAKES YOU FASTER – IT ONLY HARMS THE TRANSMISSION

The question arises again and again: "Does a CAE shifter puts more strain on a gearbox than a standard gear lever?" The answer is clear: "No!" The things that are most stressful for a synchronizer ring in a transmission are excessive shifting forces or a wrong shift in gear. Basically, the shift travel with a CAE Shifter is significantly shorter than with the standard lever. We achieve 30 - 55 % reduction depending on the vehicle and transmission type. This can only be achieved by using the appropriate gear ratio on the shift lever. You can feel it through the precision of a CAE shifter engaging the gears is much better than with a standard gear lever designed for comfort. The force for this decreases in the same proportion - we put in the gears with significantly less load for the synchronizer rings. In addition, with a correctly adjusted CAE shifter put in the gears is very precise and shifting into the wrong gear is extremely rare. Even in motorsport, fast, precise, but still sensitive shifting leads to the goal! Everything else is pure tugging and tearing which puts a disproportionately high strain on a transmission and in the worst case causes a fatal wrong shift in gear!

Included in delivery

- ▶ 1x shifter completely assembled, design depending on ordered variant (Picture A)
- ▶ 1x Shift knob incl. counter screw M6x20 V2A, design depending on ordered variant (Picture B)
- ▶ Accessories package (Bild C)



- ❗ The shifter is designed for vehicles with interior equipment. The center console must be cut out until appropriate clearance is ensured.

The removal

- ▶ Shift transmission to neutral.
- ▶ Remove shift knob, remove center console trim. (Picture 1a, 1)
- ▶ Dismantle shift lever. (Picture 1)
- ▶ Underbody: Push back bellows, remove mounting bolt for shift lever assembly and separate shift lever and shift rod assembly. (Picture 2)
- ▶ Completely remove original gearshift + shift lever bearing. (Picture 2a)
- ▶ Dismantle shift lever carrier housing (aluminum casting) for this purpose (Picture 3): Release handbrake, remove fastening bolts and nuts for cardan shaft (2x 17 open-end wrench)(Picture 4, 4a), Loosen rear engine mount. (Picture 5)

❗ IMPORTANT: POSITION GEAR JACK!

- ▶ To make it easier to remove the carrier, remove the body strut.
- ▶ Glue foam rubber into the shifter. (Picture 6)
- ▶ Remove bellows. (will be used again)
- ▶ Tighten screw 15-20NM.
- ▶ Tools: Lifting platform recommended because of shift lever carrier, hexagon nut 10, 12, 2x 17 open-end wrench, transmission jack.



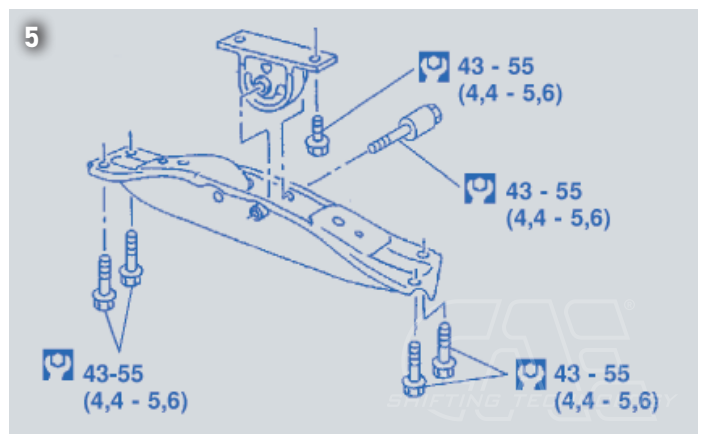
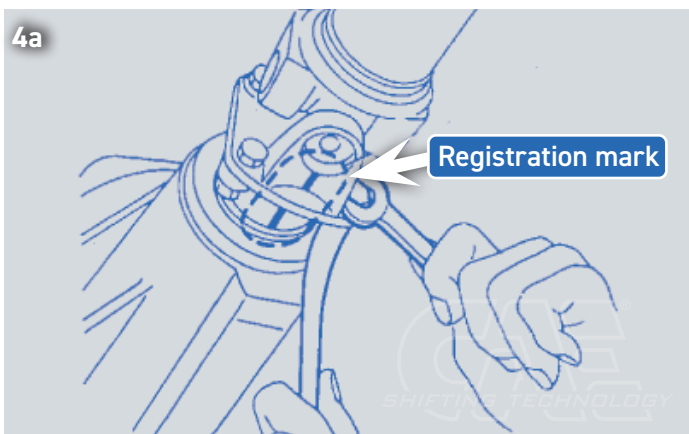
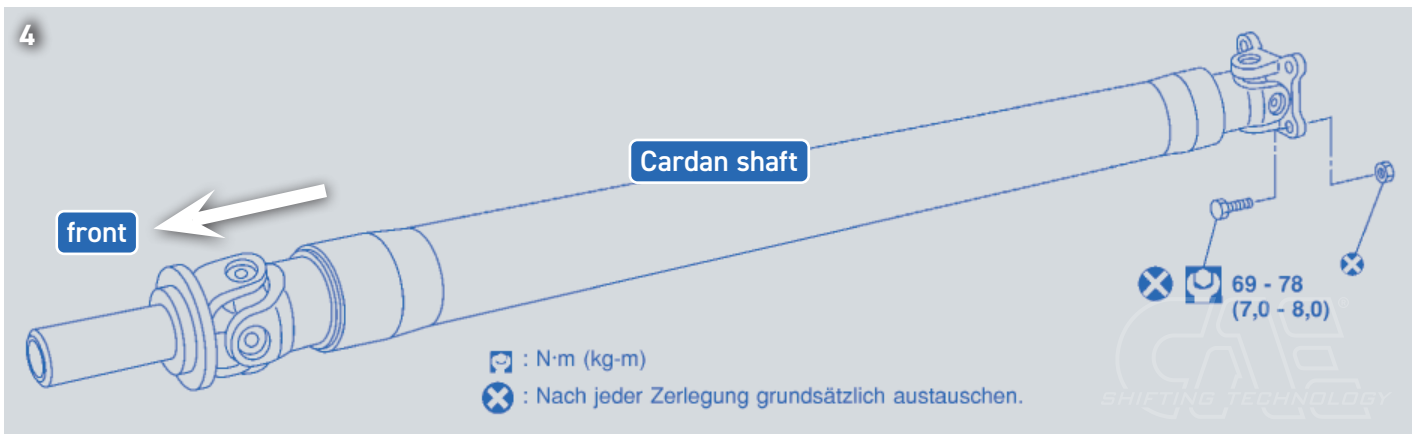
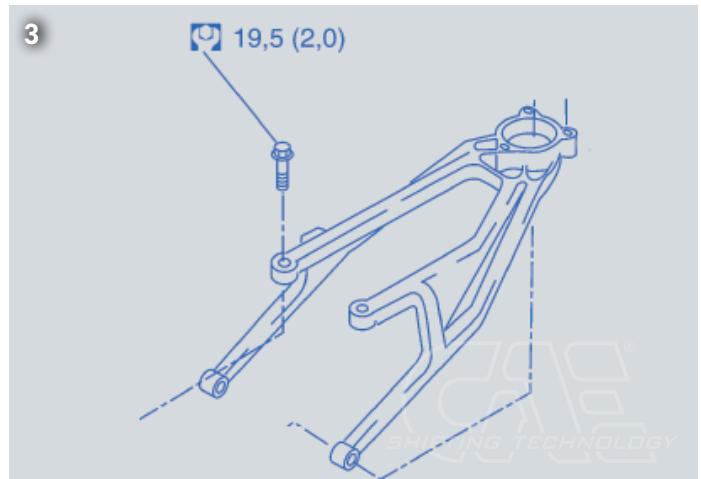
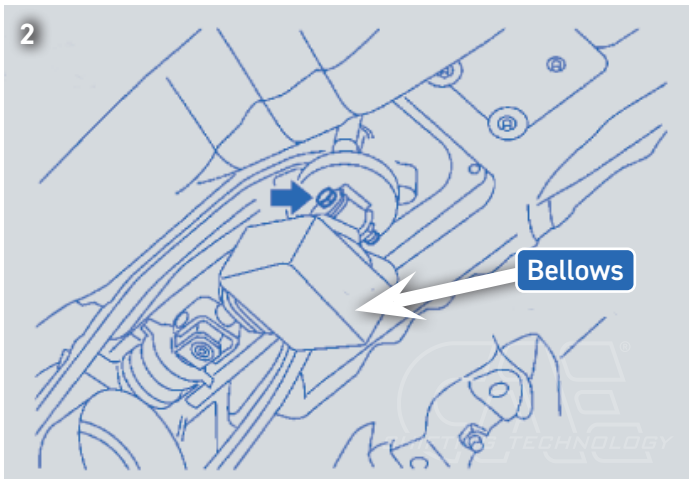
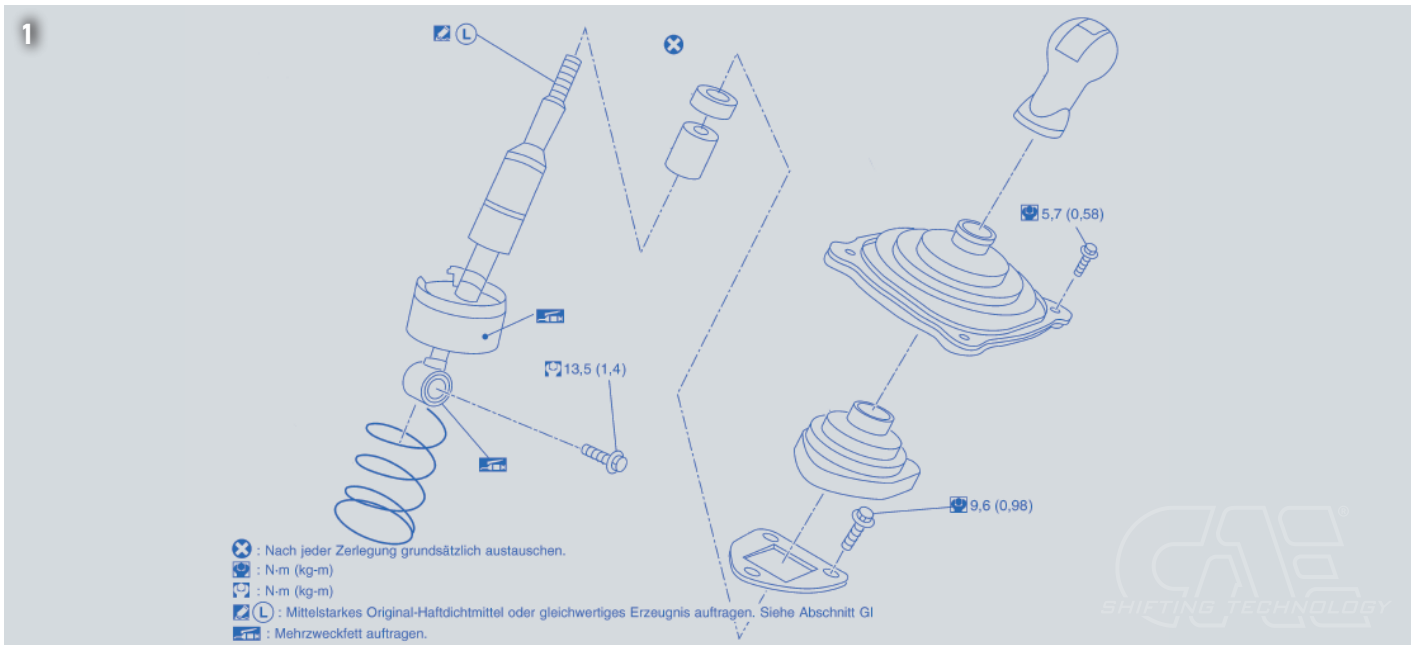

THE ROTATABLE GEARSHIFT BASE

ⓘ SHOULD NEVER BE DISASSEMBLED IF POSSIBLE!

- 📍 The fixing screw engages in the groove of the lower part of the gearshift lever and thus fixes it axially - and it must not be tightened under any conditions! The lower part of the shift lever must remain rotatable.
- 📍 **Become familiar with this principle before you install the shifter!** Note the insertion depth of the lower part at which the fixing screw engages in the groove. It must be possible to turn the lower part of the shifter without resistance in the shifter! This is a prerequisite for proper functioning.
- 📍 The basic setting for the locking screw: **Carefully** screw in until the tip of the pin rests on the bottom of the groove. Then back off ¼ turn. Now hold the grub screw with a 2.5 mm Allen key and tighten the nut (is preset). After assembly, be sure to secure the grub screw with the wire supplied!
- 📍 **Regularly spray lubrication oil into the lubrication hole \varnothing 2.5 mm above the fixing screw!**
This is absolutely necessary for proper functioning! It is essential to ensure cleanliness!
- 📍 We recommend Würth HHS 2000 for lubrication.

📍 DIRT, GRINDING DUST OR INSUFFICIENT LUBRICATION IN THIS BEARING ARRANGEMENT WILL CAUSE THE SHIFTER TO FAIL WITHIN A VERY SHORT TIME!

The following photos illustrate the principle of the rotatable shift lever base and are for explanation only!



Installation CAE Shifter

- ▶ Glue the foam rubber into the shifter. (Picture 6)
- ▶ Position the shifter on the center tunnel and fasten it with the screws supplied. (Picture 7)
- ▶ Loosen the spring stop under the gearshift bracket with a 5mm Allen key until the spring is ineffective. (Picture 8)
By loosening (max. 2 turns) the screw of the spring stop, the shift lever can later be moved loosely to align the shift rod on the bushings in the lower shifter eye.
- ▶ Grease the 2 bushings for the lower shift lever bore well and insert them into the bore. (Picture 6, 9, 10, 11)
ⓘ MAKE SURE THAT THE BEARING IS ABSOLUTELY CLEAN! DIRT, GRINDING DUST OR INSUFFICIENT LUBRICATION IN THIS BEARING WILL CAUSE THE SHIFTER TO FAIL WITHIN A VERY SHORT TIME.
- ▶ Align the shifter fork, which has also been cleaned, on the bushings in the lower shifter eye and insert the M8 screw. (Picture 12)
- ▶ When tightening the screw, make sure that the connection remains rotatable. Secure the screw additionally with the M8 nut.
ⓘ Caution: This changes the preload again!
- ▶ Additionally grease the entire lower joint after assembly.

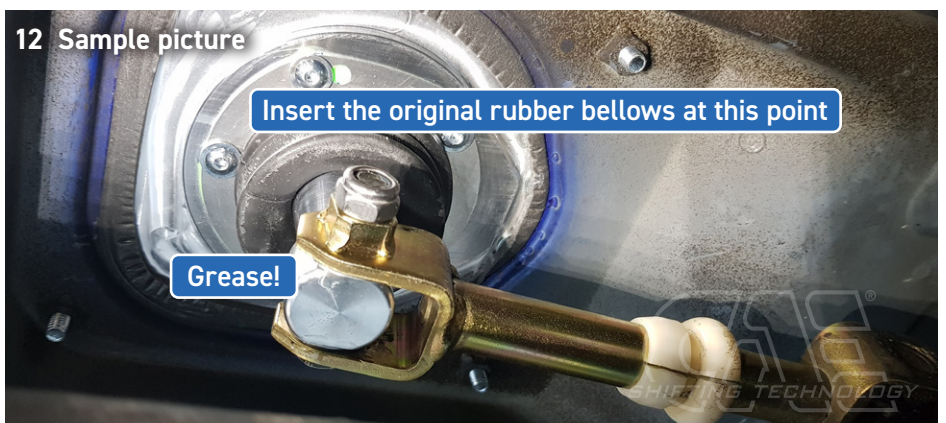
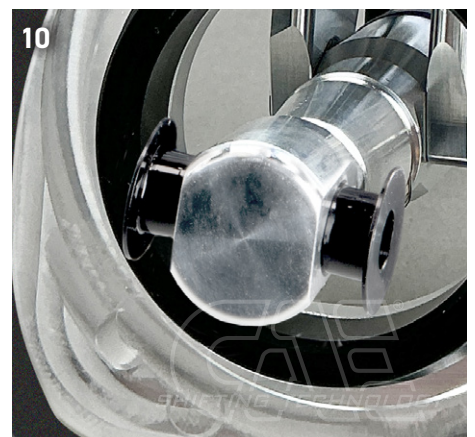
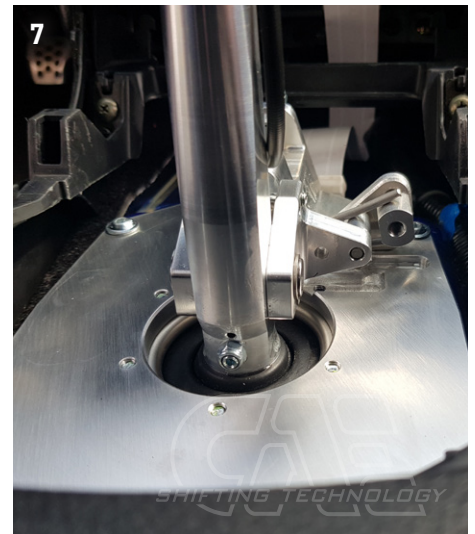

Adjusting the shifting range 6-speed gearbox

- ▶ Now tighten the spring stop on the side of the shifter. (Picture 8, 14)
- ▶ The shift lever is then exactly vertical or minimally tilted to the left! (Picture 13)

❗ CHECK: With 3rd and 4th gear engaged, the lateral clearance on the shift lever must be the same. If this is not the case, the spring stop must be readjusted. (0.5 mm is already a lot here). This is the basic adjustment of the shifter and must be done very precisely. (Picture 14)

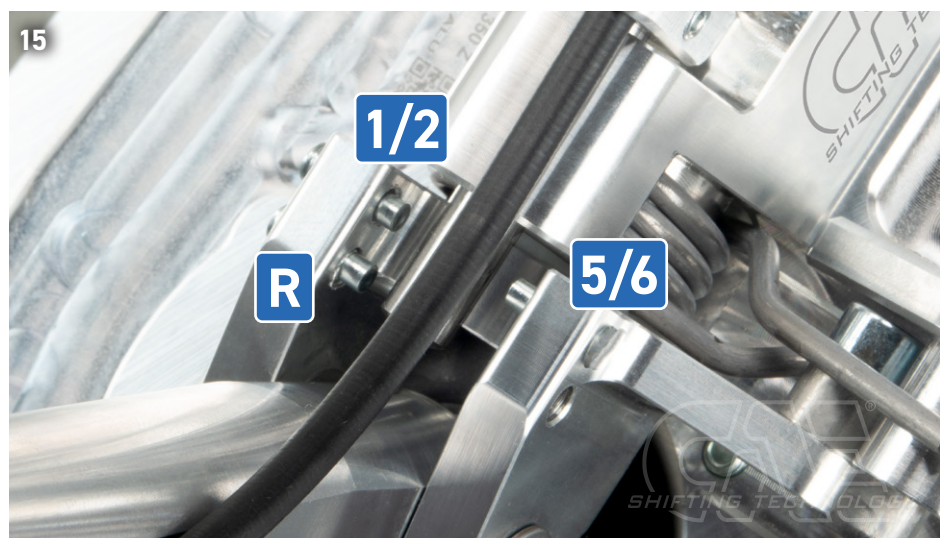
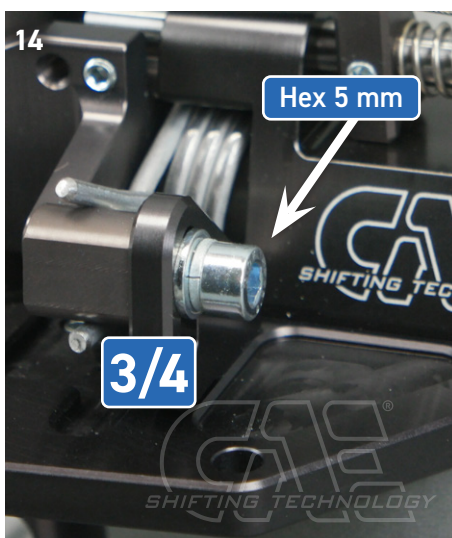
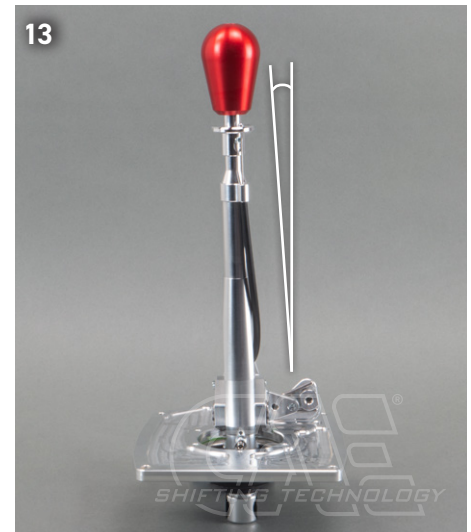

- ▶ Now shift the gearbox to level 1 / 2 using the shift lever and adjust the stop screw until the gears in level (1/2) can be changed cleanly. The adjusting screw should have a clearance of approx. 0.5 mm. (Picture 15)
- ▶ Now shift gearbox to (5/6) gear level using shift lever and screw in the stop screw until the 5th & 6th gear can be engaged cleanly. Screw has approx. 0.5mm clearance (Picture 15).
- ▶ Actuate reverse gear lock pin via pull and shift gearbox to reverse gear level. (R) Screw in corresponding stop screw until it has approx. 0.5 mm clearance. (Picture 15)



FINALLY! Check all functions and settings during the test drive and readjust if necessary!

Incorrect or inaccurate settings can cause damage to the gear box and consequential damage!

Machining the center console

- ▶ Slightly mill out the ring in the front area. If desired, cut off the shift bag from the original shifter and remount it. (Picture 16, 17, 18)

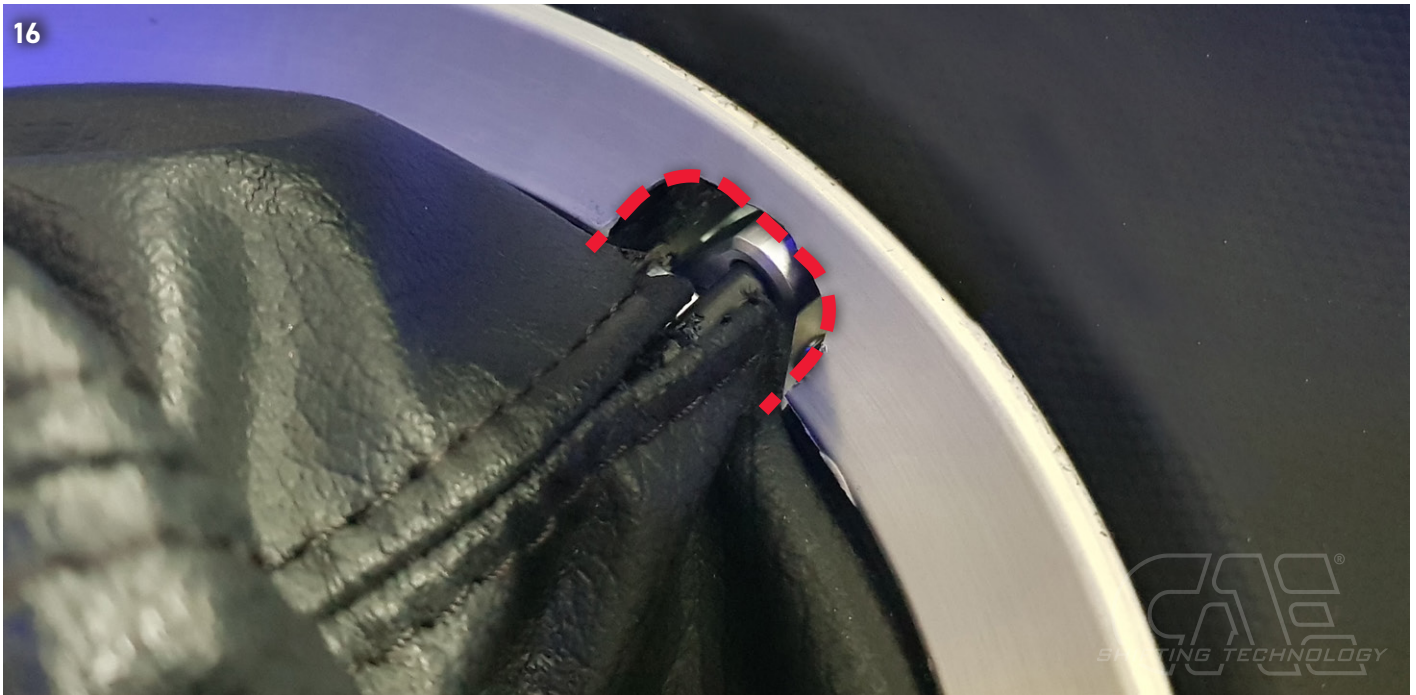

If you have any questions or problems, please be sure to contact us,
we look forward to your feedback to improve our products.

MAINTENANCE INSTRUCTIONS

- ▶ You can clean the shifter preferably with brake cleaner or IPA (isopropanol alcohol) and a soft cloth. Do not spray the cleaner directly onto the shifter (so as not to degrease the moving parts), but moisten the cloth well and then wipe it off.
- ▶ The moving parts of the shifter should be lubricated with adhesive lubricant two to three times a year. We recommend the adhesive lubricant HHS 2000 from Würth.
- ▶ Below you can see which areas should be lubricated with a spray (HHS 2000). (Depending on the model, some parts may look different or may not be present).



SCAN ME

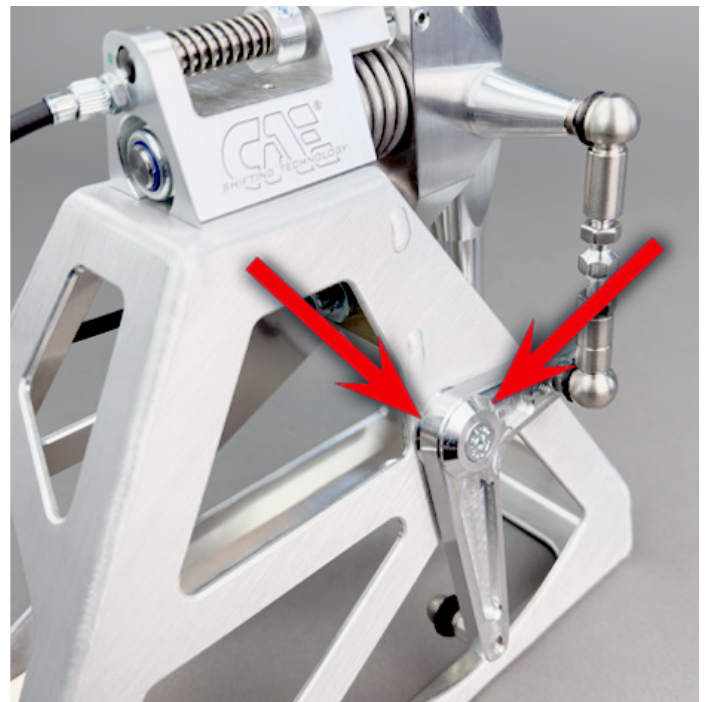
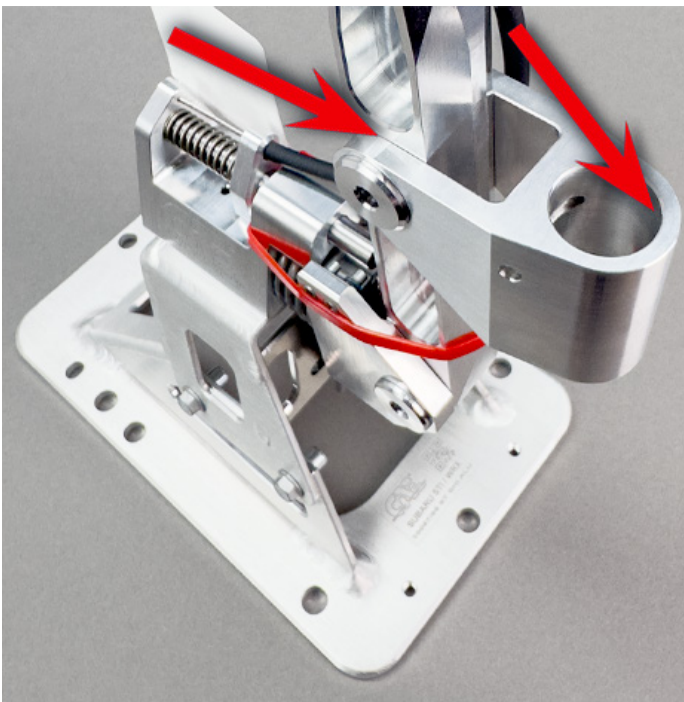
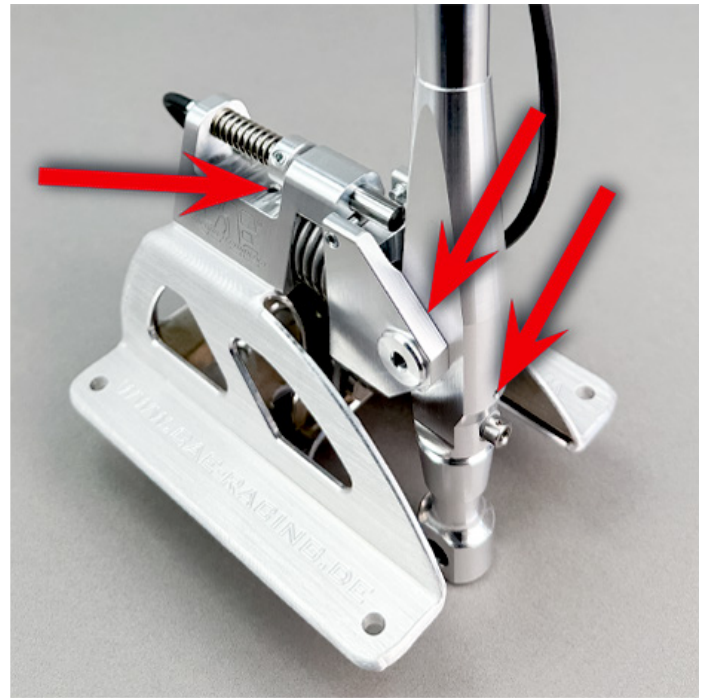



RACE THE ORIGINAL



Alte Bottroper Strasse 103
D-45356 Essen
0049. 201. 8 777 802
service@cae-racing.de

WWW.CAE-RACING.DE